

# Memo



**Date:** September 8, 2011  
**To:** City Manager  
**From:** Land Use Management, Community Sustainability (JM)  
**Application:** OCP11-0005, Z11-0047      **Owner:** 0911176 BC Ltd  
**Address:** 1170 Brant Avenue      **Applicant:** Architecturally Distinct Solutions  
**Subject:** OCP Amendment, Rezoning, Development Permit  
**Existing OCP Designations:** S2RES - Single / Two Unit Residential  
PARK - Major Park and Open Space  
**Proposed OCP Designations:** MRL - Multiple Unit Residential (Low Density)  
PARK - Major Park and Open Space  
**Existing Zone:** RU1 - Large Lot Housing  
**Proposed Zones:** RM3 - Low Density Multiple Housing  
P3 - Parks and Open Space

---

## 1.0 Recommendation

THAT OCP Bylaw Amendment No. OCP11-0005 to amend Map 4.1 of the Kelowna 2030 - Official Community Plan Bylaw No. 10500, by changing the Future Land Use designation for a portion of Lot 3, Section 30, Township 24, ODYD, Plan 10537, located on 1170 Brant Avenue, Kelowna, BC from the S2RES - Single / Two Unit Residential designation and PARK - Major Park & Open Space, to the MRL - Multiple Unit Residential (low density) and PARK - Major Park & Open Space designation, as shown on Map "A" attached to the report of Land Use Management Department dated September 8, 2011, be considered by Council;

AND THAT Council considers the APC public process to be appropriate consultation for the purpose of Section 879 of the Local Government Act, as outlined in the Report of the Land Use Management Department dated August 18, 2011;

AND THAT Rezoning Application No. Z11-0047 to amend City of Kelowna Zoning Bylaw No. 8000, by changing the zoning classification for a portion of Lot 3, Section 30, Township 24, ODYD, Plan 10537, located on 1170 Brant Avenue, Kelowna, BC, from the RU1 - Large Lot Housing zone and to the RM3 - Low Density Multiple Housing and P3 - Parks and Open Space zones, as shown on Map "B" attached to the report of the Land Use Management Department, dated September 8, 2011, be considered by Council;

A handwritten signature in the bottom right corner of the page.

AND THAT Council forward Bylaw No. 10601 authorizing a Housing Agreement between the City of Kelowna and 0911176 BC Ltd., which requires the owners to designate 4 dwelling units for owner occupied affordable housing on Lot 3, Section 30, Township 24, ODYD, Plan 10537, located at 1170 Brant Avenue, Kelowna, B.C., for reading consideration.

AND THAT the OCP Bylaw Amendment No. OCP11-0005, and zone amending bylaw be forwarded to a Public Hearing for further consideration;

AND FURTHER THAT final adoption of OCP Bylaw Amendment No. OCP11-0005 and zone amending bylaw be considered in conjunction with Council's consideration of a Development Permit on the subject property;

AND THAT final adoption of OCP Bylaw Amendment No. OCP11-0005 and zone amending bylaw be considered subsequent to the requirements of the Development Engineering Branch being completed to their satisfaction;

AND THAT final adoption of the OCP Bylaw Amendment No. OCP11-0005 and zone amending bylaw be considered subsequent to the registration of a Section 219 restrictive covenant on the title of the subject property restricting the number of dwellings on the parcel to no more than 18 units;

## **2.0 Purpose**

To amend the Official Community Plan (OCP) future land use designation for a portion of the subject property from "Single / Two Unit Residential" and "Major Park and Open Space" to "Multiple Unit Residential (Low Density)" and "Major Park and Open Space". To rezone the subject property from RU1 - Large Lot Housing to RM3 - Low Density Multiple Housing to allow the development of 18 townhouse units, 4 of which are to be designated as affordable housing. To consider the form and character of the proposed 18 unit residential development.

## **3.0 Land Use Management**

While Land Use Management staff have significant reservations regarding the proposed development - each of which will be discussed below - staff recognize the overall merits of the proposal and are generally supportive.

To begin, a 9 lot single family subdivision has already been approved for the parcel. Under the current designation in the Kelowna 2030 - Official Community Plan (OCP) secondary suites would be encouraged. Were each home to rezone to permit a suite, the total number of dwelling units would be 18, which is equal to the number presently proposed by the applicant in the form of townhouse units. The applicant is prepared to limit this density to 18 through the registration of a restrictive covenant. So, through the lens of the OCP, with a no net increase in density, the most significant difference between what is presently approved and what is proposed is the housing form.

An additional community benefit that the applicant has proposed is the designation of 20% (4 units) of the units as affordable housing. In order to meet City standards, these units will have to be secured via Housing Agreement. This would represent the securing of high quality units for families. Such a gesture is seen to be a substantial benefit to the City, as the current 9 lot subdivision offers no affordable housing.

Further, while not located in an urban or village centre, the development is situated in a manner that provides easy access to transit and to active modes of transportation. In terms of transit, it is anticipated that regular bus service will soon be extended to near the intersection of Brant Avenue and Gordon Drive. This would place the development within easy walking distance of transit. The proposal is also in close proximity to a major active modes corridor (Rails with Trails and Cawston Avenue pathways). Each of the above alternatives increases the likelihood that residents will not be automobile dependent.

The proposal also represents a form of sensitive hillside development that attempts to follow the natural slopes on the parcel, rather than relying on large cuts and fills. Through the proposal, steep slopes and natural areas will be preserved. As part of the approved subdivision, the applicant has already conducted significant riparian restoration along Brant Avenue.

Despite the above, Land Use Management staff do have concerns with the proposed OCP amendment and rezoning. Principally, the recently adopted Kelowna 2030 - Official Community Plan is built around the concept of creating complete communities by directing development towards Urban and Village Centres. This foundational concept is representative of good planning practice that aims to capitalize on the advantages provided by denser Urban Centres, such as:

- Mixed-use development that improves ease of access to services, facilities and employment; and
- Reduced vehicle use, as more services and employment are easily accessible by walking.

It is the combination of the factors above, in addition to others, that work together to create vibrant, efficient and sustainable urban environments. The proposed development is not situated in an Urban Centre.

A further matter of concern is the location of the parcel relative to potentially conflicting land uses. Brant Avenue extends from Gordon Drive through established industrial development to its end in the subject property. The only buffer between the proposed development and adjacent industrial development is limited vegetation and a difference in elevation of approximately 7-10m. Staff is not confident that these limited measures are adequate to mitigate the potential for nuisance from adjacent uses, such as light, noise, and odours.

Complicating this issue is the relative isolation of the parcel from its abutting residential neighbours. Even though the parcel shares two property lines with adjacent residential development, residents are unable to access these areas. As a result, residents are more likely to interact on a daily basis with adjacent industrial uses, rather than to more compatible residential uses. As the applicant is targeting the proposed development towards young families, the addition of up to 18 young families on the parcel increases the potential for land use conflicts that may place residents at additional risk.

In summary, even though the proposed development is not an ideal representation of the OCP's vision, it does offer significant benefits over and above the alternative single detached housing form that is already approved for the parcel. Specifically, the addition of affordable housing, the registration of a covenant to limit the density to 18 units, design that embodies the Hillside Development Guidelines, and the ease of access to alternative modes of transportation for future residents provide the basis for a compelling rationale to support the proposal.

## 4.0 Proposal

### 4.1 Background

Until recent years, the subject property contained a single detached dwelling with principal access from Brant Avenue. Between 2005 and 2009, the property has been the subject of multiple development applications, as outlined in *Table 1*.

Table 1: Application Chronology	
Year	Proposal
2005	Rezone from RU1 to RU5 to permit a 9-lot bareland strata development. Withdrawn by applicant prior to APC review.
2007	OCP amendment and rezoning to allow a 32-unit townhouse development. Defeated by Council.
April, 2009	OCP amendment and rezoning to allow townhouse development. Withdrawn by applicant.
August, 2009	Subdivision application under existing zoning for 9 single family lots. Approved by staff and infrastructure in place.
June, 2011	OCP amendment and rezoning to allow an 18-unit townhouse development.

Presently, the property owner has received Preliminary Layout Review (PLR) approval for a 9 lot subdivision under existing zoning. Alongside this approval, the owner was required to obtain a Natural Environment Development Permit. The required infrastructure for this development is in place.

In addition to the required OCP amendment and rezoning, the present application requires both an update to the existing Natural Environment and Hazardous Conditions Development Permit and a new Form and Character Development Permit.

The proposal was considered by the Advisory Planning Commission at its meeting of August 2, 2011, where it received support.

### 4.2 Project Description

The subject property is situated between the industrialized area at the north end of Gordon Drive and the adjacent residential neighbourhood to the east. Access onto the site will be the private drive at the end of Brant Avenue. The proposed 42 (33 required) parking stalls will be located at grade and spread throughout the site.

The proposed development is comprised of five buildings containing a total of 18 townhouse units. It is proposed that 6 of these units be designated as affordable in accordance with City of Kelowna standards through a housing agreement. Of the proposed units, there will be 12 three bedroom townhomes, and 6 two bedroom townhomes. Each unit is provided a directly accessible private yard space. Parking and bicycle parking will be located in the garages and carports provided to each dwelling unit. This form of residential development is seen primarily to provide accommodation to families.

The proposed building materials consist primarily of wicker, pebble and saddle brown coloured horizontal vinyl siding and canyon clay and wicker coloured vertical vinyl siding. Textured exterior window trim will be applied to this development. Wood timbers and cultured stone are also used as accent material.

As the slope presents challenging development conditions, the buildings are stepped in order to adjust to the contours.

Landscaping for the property features a variety of native plant species that are suited to the local climate, such as Douglas Maple, Kinnikinnick, Bluebunch Wheatgrass, and Brown Eyed Susan. The Landscape Plan also includes erosion control matting and hydroseeding. The large majority of the planting is planned for the western property boundary and flanking the internal roadway. No planting is proposed for the northern or eastern property boundaries abutting adjacent residential development.

As part of the Natural Environment Development Permit, the applicant is also undertaking planting and restoration of the south side of Brant Avenue. The majority of this work has been completed under the approved 9 lot subdivision.

#### 4.3 Site Context

The subject property is situated on a sloped parcel that is adjacent to industrial development to the west, low density residential development to the north and east, and Brandt's Creek to the south.

The parcel is within the Permanent Growth Boundary but is outside of the Core Area and designated Urban and Village Centres, as outlined in Maps 5.1 - 5.3 of the Official Community Plan.

Direction	Zone
North	RU1 - Large Lot Housing / RU1s - Large Lot Housing with Secondary Suite
West	I2 - General Industrial
East	RU1 - Large Lot Housing
South	I4 - Central Industrial

4.4 Subject Property Map: 1170 Brant Avenue

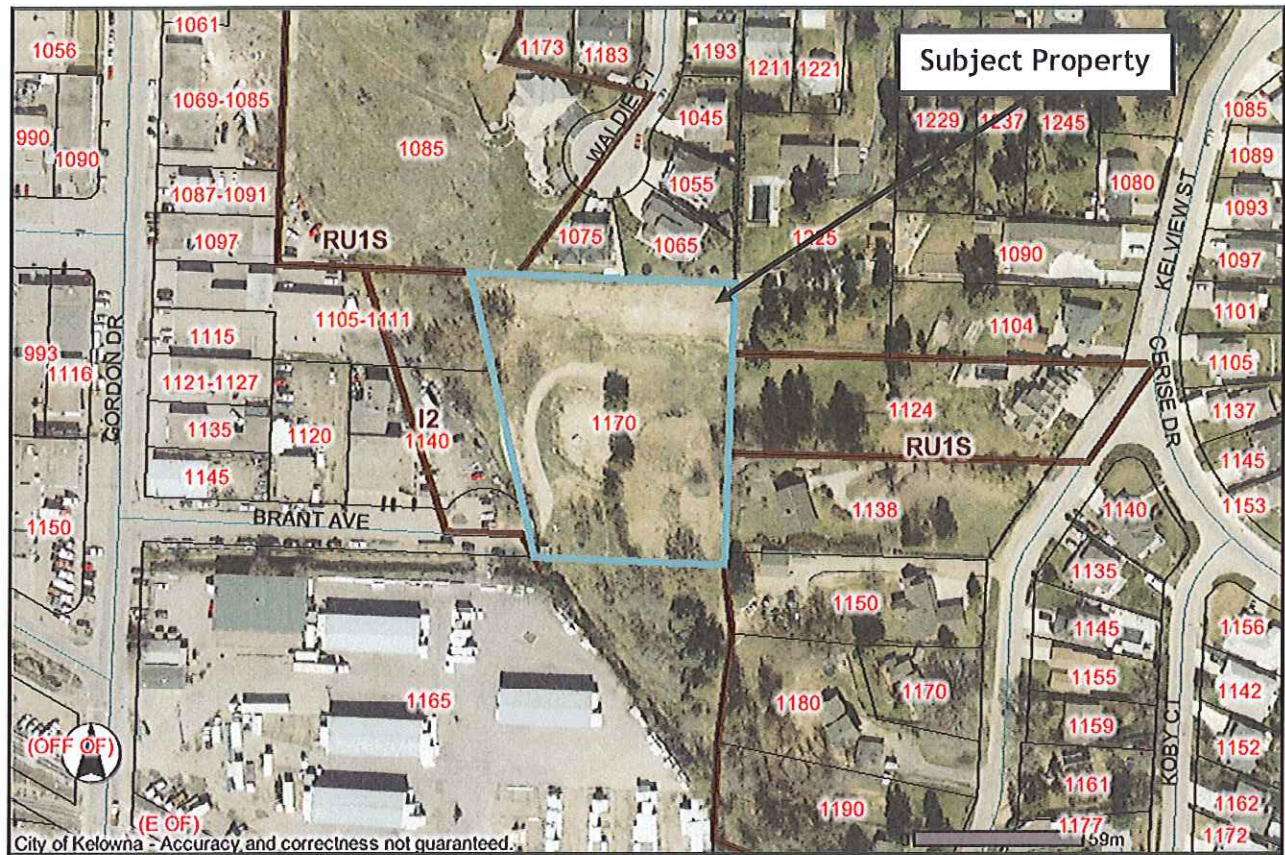

4.5 Zoning Analysis Table

Zoning Analysis Table		
CRITERIA	PROPOSAL	RM3 ZONE REQUIREMENTS
Subdivision Regulations		
Lot Area	7,615m <sup>2</sup>	900m <sup>2</sup>
Lot Width	Exceeds	30.0m
Lot Depth	exceeds	30.0m
Development Regulations		
Floor Area Ratio	0.26	0.5
Height	9.2m and 2 ½ storeys	Lesser of 9.5m or 2 ½ storeys
Front Yard	4.5m	4.5m
Side Yard (south)	4.0m for 1 - 1 ½ storey portion / 4.5m for 2 - 2 ½ storey portion	4.0m for 1 - 1 ½ storey portion / 4.5m for 2 - 2 ½ storey portion
Side Yard (north)	4.0m for 1 - 1 ½ storey portion / 4.5m for 2 - 2 ½ storey portion	4.0m for 1 - 1 ½ storey portion / 4.5m for 2 - 2 ½ storey portion
Rear Yard	7.5m	7.5m
Other Regulations		

Minimum Parking Requirements	42	33
Bicycle Parking	Class I - 9 (in garage/carport) Class II - 2	Class I - 9 Class II - 2
Private Open Space	exceeds	25.0m <sup>2</sup> per dwelling unit over 1 bedroom
Separation Between Buildings	3.0m	3.0m

## 5.0 Current Development Policies

### 5.1 Kelowna Official Community Plan (OCP)

#### Goals for a Sustainable Future<sup>1</sup>

**Contain Urban Growth.** Reduce greenfield urban sprawl and focus growth in compact, connected and mixed-use (residential and commercial) urban and village centres.

**Address Housing Needs of All Residents.** Address housing needs of all residents by working towards an adequate supply of a variety of housing.

#### General Development Process policies:

**Complete Suburbs.<sup>2</sup>** Support a mix of uses within Kelowna's suburbs (see Map 5.1 - Urban Core Area), in accordance with "Smart Growth" principles to ensure complete communities. Uses that should be present in all areas of the City (consistent with Map 4.1 - Future Land Use Map), at appropriate locations, include: commercial, institutional, and all types of residential uses (including affordable and special needs housing) at densities appropriate to their context. Building heights in excess of four storeys will not be supported within the suburban areas, unless provided for by zoning existing prior to adoption of OCP Bylaw 10500.

**Complete Communities.<sup>3</sup>** Support the development of complete communities with a minimum intensity of approximately 35 - 40 people and/or jobs per hectare to support basic transit service - a bus every 30 minutes.

**Compact Urban Form.<sup>4</sup>** Develop a compact urban form that maximizes the use of existing infrastructure and contributes to energy efficient settlement patterns. This will be done by increasing densities (approximately 75 - 100 people and/or jobs located within a 400 metre walking distance of transit stops is required to support the level of transit service) through development, conversion, and re-development within Urban Centres (see Map 5.3) in particular and existing areas as per the provisions of the Generalized Future Land Use Map 4.1.

<sup>1</sup> City of Kelowna Official Community Plan, Chapter 1, Introduction, "Goals for a Sustainable Future".

<sup>2</sup> City of Kelowna Official Community Plan, Policy No. 5.2.3, Chapter 5

<sup>3</sup> City of Kelowna Official Community Plan, Policy No. 5.2.4, Chapter 5

<sup>4</sup> City of Kelowna Official Community Plan, Policy No. 5.3.2, Chapter 5

**Maximize Pedestrian / Cycling Connectivity.**<sup>5</sup> Require that pedestrian and cyclist movement and infrastructure be addressed in the review and approval of all City and private sector developments, including provision of sidewalks and trails and recognition of frequently used connections and informal pedestrian routes. With new developments, require dedication of on-site walking and cycling paths where necessary to provide links to adjacent parks, schools, transit stops, recreation facilities, employment nodes, cul-de-sacs and large activity areas.

**Active Transportation Networks.**<sup>6</sup> As redevelopment occurs within and around Urban Centres, seek public pathways that would complement linear parks, multi-use trails, parks, plazas, greenways or sidewalks to form continuous pedestrian and bicycle networks and/or connections between centres where possible. (See Map 7.1 - Active Transportation Corridors.)

**Protect Sensitive Areas.**<sup>7</sup> Sensitive environmental areas and riparian management areas (RMA) will be protected by siting trails beyond their boundaries, unless there are absolutely no alternatives.

**Steep Slopes.**<sup>8</sup> Prohibit development on steep slopes (+30% or greater for a minimum distance of 10 metres) except where provided for in ASPs adopted or subdivisions approved prior to adoption of OCP Bylaw 10500.

#### Residential Land Use Policies:

**Cluster Housing.**<sup>9</sup> Require new residential development to be in the form of cluster housing on / or near environmentally sensitive areas and areas of steeper slopes to lessen site disturbance and environmental impact on those areas identified on the Future Land Use Map 4.1 as single-two unit residential hillside. Steeply sloped areas should be retained as natural open space, public or private. The intent of the clustering would be to preserve features identified through the Development Permit process that otherwise might be developed and to maximize open space in order to:

- a. Protect environmentally sensitive areas of a development site and preserve them on a permanent basis utilizing the most appropriate tools available;
- b. Facilitate creative and flexible site design that is sensitive to the land's natural features and adaptive to the natural topography;
- c. Decrease or minimize non-point source (i.e. asphalt roofs, driveways and parking) pollution impacts by reducing the amount of impervious surfaces in site development;
- d. Promote overall cost savings on infrastructure installation and maintenance; and
- e. Provide opportunities for social interaction, walking and hiking in open space areas.

#### OCP Amendment Applications:

**Evaluation Checklist.**<sup>10</sup> Evaluate development applications that require an OCP amendment on the basis of the extent to which they comply with underlying OCP objectives, including the following:

---

<sup>5</sup> City of Kelowna Official Community Plan, Policy No. 5.10.3, Chapter 5

<sup>6</sup> City of Kelowna Official Community Plan, Policy No. 5.10.1, Chapter 5

<sup>7</sup> City of Kelowna Official Community Plan, Policy No. 5.14.4, Chapter 5

<sup>8</sup> City of Kelowna Official Community Plan, Policy No. 5.15.12, Chapter 5

<sup>9</sup> City of Kelowna Official Community Plan, Policy No. 5.22.1, Chapter 5

<sup>10</sup> City of Kelowna Official Community Plan, Policy No. 5.40.1, Chapter 5



- Does the proposed development contribute to preserving lands with slopes greater than 30%? *Yes. Slopes greater than 30% will be conserved via restrictive covenant.*
- Does the proposed development respect the OCP Permanent Growth Boundary (OCP Map 4.1)? *Yes. The proposed development is situated within the Permanent Growth Boundary.*
- Does the proposed development feature a mix of residential, employment, institutional, and/or recreational uses within individual buildings or larger development projects? *No. Residential uses only.*
- Is the proposed development located in an Urban Centre? *No.*
- Does the proposed development increase the supply of affordable (as defined in the OCP) apartments or townhouses? *Yes. 4 units are proposed to be affordable housing.*
- Is the property serviced with water and City sanitary sewer at the time of application? *Yes. However, it has yet to be established if existing services are adequate for the proposal.*
- Would the proposed project help decrease the rate of travel by private automobile, especially during peak hours? *No. It is generally accepted that residents will not regularly walk to services located over 10 minutes away by foot (approximately 400m). Most services (groceries, restaurants, etc...) are situated in excess of 400m from the proposed development.*
- Does the proposed project involve redevelopment of currently under-utilized, urbanized land? *No. Land is presently used for large lot housing, which is consistent with established Future Land Use.*
- Does the proposed project result in the creation of substantially more public open space than would be available if the development were not to proceed (not including required open space dedications or non-developable areas)? *No. The proposed development does not provide significant public open space.*
- Is there a deficiency of properties within the applicable Sector (see Map 5.4) that already have the required OCP designation? *No. There is an adequate supply of Multiple Unit Residential (Low Density) land already designated within the established Urban and Village Centres.*
- Does the project avoid negative impacts (shadowing, traffic etc.) on adjoining properties where those adjoining properties are not slated for land use changes? *No. Additional residential vehicle traffic may conflict with industrial vehicle traffic.*
- Is the project consistent with the height principles established in the OCP? *Yes. Height is limited to 2 ½ storeys.*
- If the project goes ahead, would surrounding property owners be likely to develop their properties as per OCP Future Land Use and other City policy provisions? *The proposed development would not impede surrounding property owners from developing as per OCP Future Land Use and other City policy provisions.*
- Would approval of the project enhance the surrounding neighbourhood? *Unclear. The subject property is isolated from the surrounding neighbourhood. It is not anticipated that the project will be detrimental to adjacent residential lots.*
- Could the project be supported without over-burdening existing park and other community resources or threatening the viability of existing neighbourhood resources? *Unclear. This question will be answered during file circulation.*

Comprehensive Development Permit Objectives:

- Convey a strong sense of authenticity through urban design that is distinctive for Kelowna;
- Promote a high urban design standard and quality of construction for future development that is coordinated with existing structures;
- Integrate new development with existing site conditions and preserve the character amenities of the surrounding area;
- Promote interesting, pedestrian friendly streetscape design and pedestrian linkages;
- Provide for a scale and massing of commercial buildings that promotes a safe, enjoyable living, pedestrian, working, shopping and service experience;
- Incorporate architectural features and detailing of buildings and landscapes that define an area's character;
- Promote alternative transportation with enhanced streetscapes and multimodal linkages;
- Highlight the significance of community institutional and heritage buildings; and
- Protect and restore the urban ecology (i.e. architectural and site consideration with respect to the ecological impact on urban design);
- Moderate urban water demand in the City so that adequate water supply is reserved for agriculture and for natural ecosystem processes;
- Reduce outdoor water use in new or renovated landscape areas in the City by a target of 30%, when compared to 2007.

Comprehensive Development Permit Guidelines:

- Incorporate landscaping and building form and character that is distinct to Kelowna and the Central Okanagan and conveys a sense of authenticity;
- Incorporate forms and images that relate to the region's natural and cultural landscapes (e.g. incorporate winery or orchard inspired trellises or rooflines that reflect those found on barns and older homes located on/around agricultural lands);
- Respond architecturally to summer sun with buildings that have overhangs and recesses of sufficient depth to provide comfort and shade;
- Incorporate materials that relate to the character of the region and the context of the surrounding neighbourhood;
- Use colours found in the region's natural and cultural landscape;
- Provide generous outdoor spaces, including rooftops, balconies, patios and courtyards, to allow residents to benefit from the favourable Okanagan weather;
- Incorporate techniques and treatments that emphasize the transition between inside and outside (e.g. operable windows, overhead rolling doors, canopies, trellises, recessed entrances, and extended building planes);
- Design new multi-storey buildings to transition in height where the OCP land use designation provides for smaller structures on adjoining lots;
- Design developments with multiple buildings such that there is a sense of architectural unity or cohesiveness;
- Design developments with multiple, separate buildings such that individual buildings are of different but compatible shapes, masses, and exterior finishes;

- Utilize landscaping treatments to further soften the mass of building form (e.g. strategic placement of trees, shades and vines, trellis and arbours, along with surface materials such as pavers);
- Orient public and private open spaces to take advantage of sunlight with the provision of shade and protection from wind and other climatic elements (design for microclimate);
- Promote the use of alternative modes of transportation in site design (e.g. prominent bicycle racks for convenience and security, orient building entrances to pedestrian areas);
- Ensure pedestrian circulation is convenient, safe, and clearly identifiable to drivers and pedestrians;
- Incorporate landscaping that:
  - Compliments and softens the architectural features and edges of buildings;
  - Considers the context of surrounding properties where there is a dominant pattern along the street (i.e., provide street trees and landscaping consistent with the established or emerging standards on the street or adjacent neighbourhood);
  - Enhances the pedestrian experience (e.g. aesthetics, relief from weather);
  - Adds texture and three dimensional components to the site (e.g. vegetated canopy);
  - Helps screen parking areas, mechanical functions, and garbage and recycling areas;
  - Respects required sightlines from roadways and enhances public views;
  - Contributes towards a sense of personal safety and security;
  - Retains existing healthy, mature trees and vegetation (including those with special character or historical and cultural significance);
  - Utilizes native plants that are drought tolerant;
  - Mitigates undesirable architectural elements (e.g. blank walls can be covered with trellis and trained with vines);
  - Defines distinct private outdoor space for all ground-level dwellings.

Provide fences and retaining walls with visual interest (e.g. high quality fencing, stone or rock walls) and human scale (e.g. punctuate at regular intervals with vertical elements such as piers or landscaping).

## 6.0 Technical Comments

### 6.1 Building & Permitting Department

- 1) Development Cost Charges (DCC's) are required to be paid prior to issuance of any Building Permit(s) for new construction.
- 2) Spatial calculations for unprotected openings and exterior cladding to be defined for between buildings 1&2 and 3&4. Spatial calculations and / or an alternative solution for and second floor windows of one unit directly above a single story unit beside (interior units) to be approved prior to the release of the development permit.
- 3) A Building Code analysis is required for the structure at time of building permit applications, but the following items may affect the form and character of the building. Retaining wall(s) to be defined in the development permit to establish changes in grades as well as proper drainage slopes away from the buildings.
- 4) Architectural drawings will require the fire stopping details for offset floor locations to be provided at time of building permit application.

- 5) Full Plan check for Building Code related issues will be done at time of Building Permit applications.

6.2 Development Engineering Department

See attached City of Kelowna Memorandum.

6.3 Parks and Public Spaces

A future trail is planned to link Brant Avenue with Clement alongside Brandts Creek. Zoning and OCP boundaries should reflect the required creek setbacks. Further actions are not recommended at this time, as key land required for the development of the trail (1165 Brant) is likely to remain unavailable except in the long term.

6.4 Transportation

The area of Gordon Dr and Clement is currently served by the #7 Glenmore transit route offering 7 day a week service with an average of 16 hour service per day. This route offers peak schedule frequency of 15 minutes and half hour service mid day (weekdays). Currently stops are located on Graham St just south of Clement but consideration could be given to relocating these stops onto Clement in the Gordon Drive area. The Transit Future Plan, the area's recently completed transit master plan, identify Gordon Dr as the location of a new frequent transit (FTN) route set for implementation in the near term (1 to 3 years max). This new FTN line will route via Gordon Dr linking the Capital News Center in the south to downtown. I believe the line will route via Clement Ave or Waddell as it passes through the north end. In implementing this line stops will be included in close proximity to the Gordon Dr and Clement intersection.

It is my feeling that the proposed development on Brant Ave will have strong transit service in the future provided via the new Gordon Dr FTN and the existing #7 Glenmore service. Residents are considered within reasonable access to transit service when within 400 meters of an FTN or regular commuter route. It is worth noting that the development is also in close proximity to a major bicycle corridor as well (Rails with Trails/Cawston Ave pathways) providing direct connection to downtown and the Parkinson Landmark area. Connection from Brant Ave to this facility would be complimented by the addition of on street bike lanes on Gordon Drive's north section.

6.5 Fire Department

The access road should not exceed 12% grade. A fire hydrant of 90ltr/sec. is required as per the City of Kelowna Subdivision Bylaw #7900.

6.6 Public Health Inspector

This office has no objection to the proposal. As the proposed development will be serviced by existing community drinking water and sewerage systems, we have no objection to this proposal from a servicing perspective. Further, as the proposal will allow for higher density dwellings, we support this application from a healthy built environment perspective.

6.7 RCMP

No comments.

6.8 School District No. 23

No comments.

6.9 Telus

TELUS will provide underground facilities to this development. Developer will be required to supply and install conduit as per TELUS policy

6.10 Shaw Cable

No comment.

6.11 Fortis BC

No comment.

6.12 Real Estate & Building Services

No comment.

7.0 Application Chronology

Date of Application Received: July 27, 2011

Advisory Planning Commission August 2, 2011

The above noted application was reviewed by the Advisory Planning Commission at the meeting on August 2, 2011 and the following recommendations were passed:

THAT the Advisory Planning Commission supports Official Community Plan Amendment Application No. OCP11-0005 for 1170 Brant Avenue to amend the future land use designations of part of the subject property from the "Single/Two Unit Residential" and "Major Park and Open Space" designations to the "Multiple Unit Residential (Low Density)" and "Major Park and Open Space" designations.  
CARRIED

THAT the Advisory Planning Commission supports Rezoning Application No. Z11-0047 for 1170 Brant Avenue to rezone the subject property from the RU1 - Large Lot Housing zone to the RM3 - Low Density Multiple Housing zone in order to allow the development of 18 townhouse units, 6 of which are to be designated as affordable housing in accordance with City-endorsed formulas.

AND THAT the Advisory Planning Commission supports Development Permit Application No. DP11-0101 for 1170 Brant Avenue for the form and character of the proposed 18 unit development.

CARRIED

Report prepared by:



James Moore, Land Use Planner

Reviewed by:



Jim Paterson, General Manager of Community Sustainability

Approved for Inclusion



Shelley Gambacort, Director, Land Use Management

Attachments:

Subject Property Map  
Map "A" - Proposed Future Land Use Map  
Map "B" - Proposed Zoning Map  
Site Plan  
Conceptual Elevations  
Landscape Plan  
City of Kelowna Memorandum, dated August 19, 2011  
Housing Agreement  
Applicant's Design Rationale JM

2011 AUG 19 10:00 AM  
CITY OF KELOWNA  
COMMUNITY DEVELOPMENT



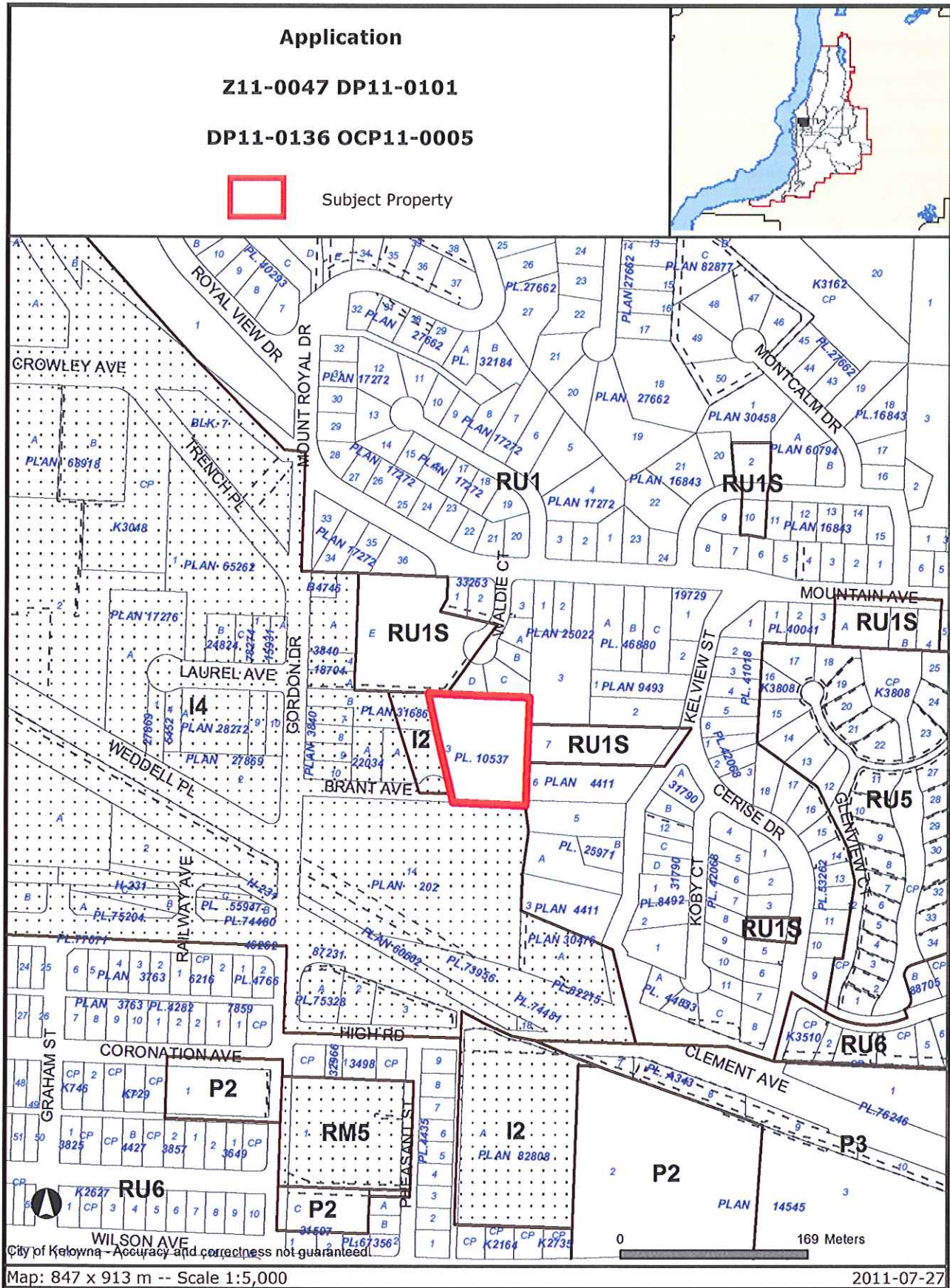

Certain layers such as lots, zoning and dp areas are updated bi-weekly. This map is for general information only.  
 The City of Kelowna does not guarantee its accuracy. All information should be verified.

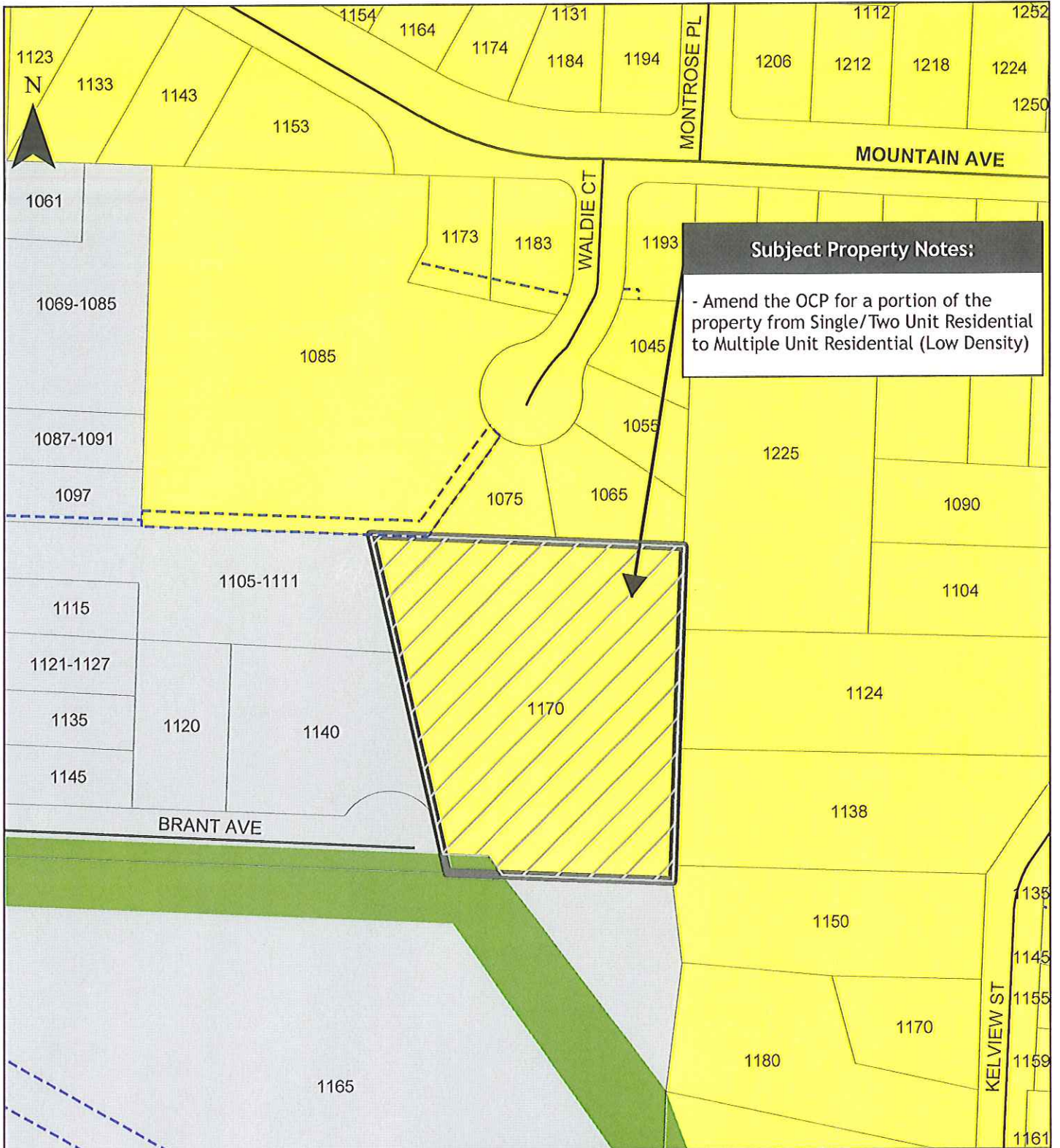

**Subject Property Notes:**

- Amend the OCP for a portion of the property from Single/Two Unit Residential to Multiple Unit Residential (Low Density)

**MAP "A" OCP AMENDMENT  
OCP11-0005**

- Industrial
- Major Park and Open Space
- Railway
- Single / Two Unit Residential
- Subject Property
- Portion of Subject Property
- Legal Parcel
- Easement

This map is for general information only. The City of Kelowna does not guarantee its accuracy. All information should be verified.

0 20 40 Meters





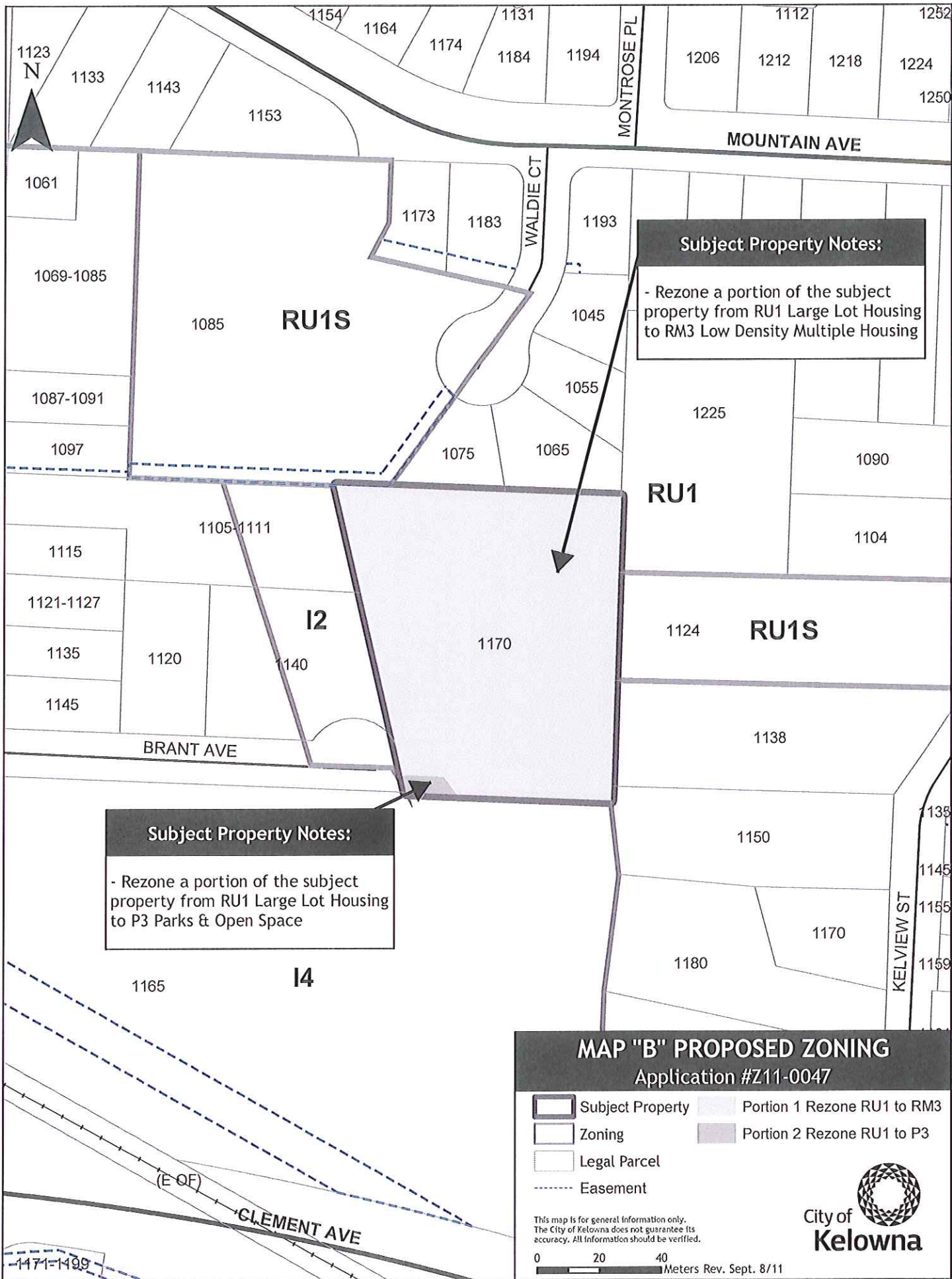

**Subject Property Notes:**  
 - Rezone a portion of the subject property from RU1 Large Lot Housing to RM3 Low Density Multiple Housing

**Subject Property Notes:**  
 - Rezone a portion of the subject property from RU1 Large Lot Housing to P3 Parks & Open Space

**MAP "B" PROPOSED ZONING**  
 Application #Z11-0047

- Subject Property
- Zoning
- Legal Parcel
- Easement
- Portion 1 Rezone RU1 to RM3
- Portion 2 Rezone RU1 to P3

This map is for general information only. The City of Kelowna does not guarantee its accuracy. All information should be verified.  
 0 20 40 Meters Rev. Sept. 8/11







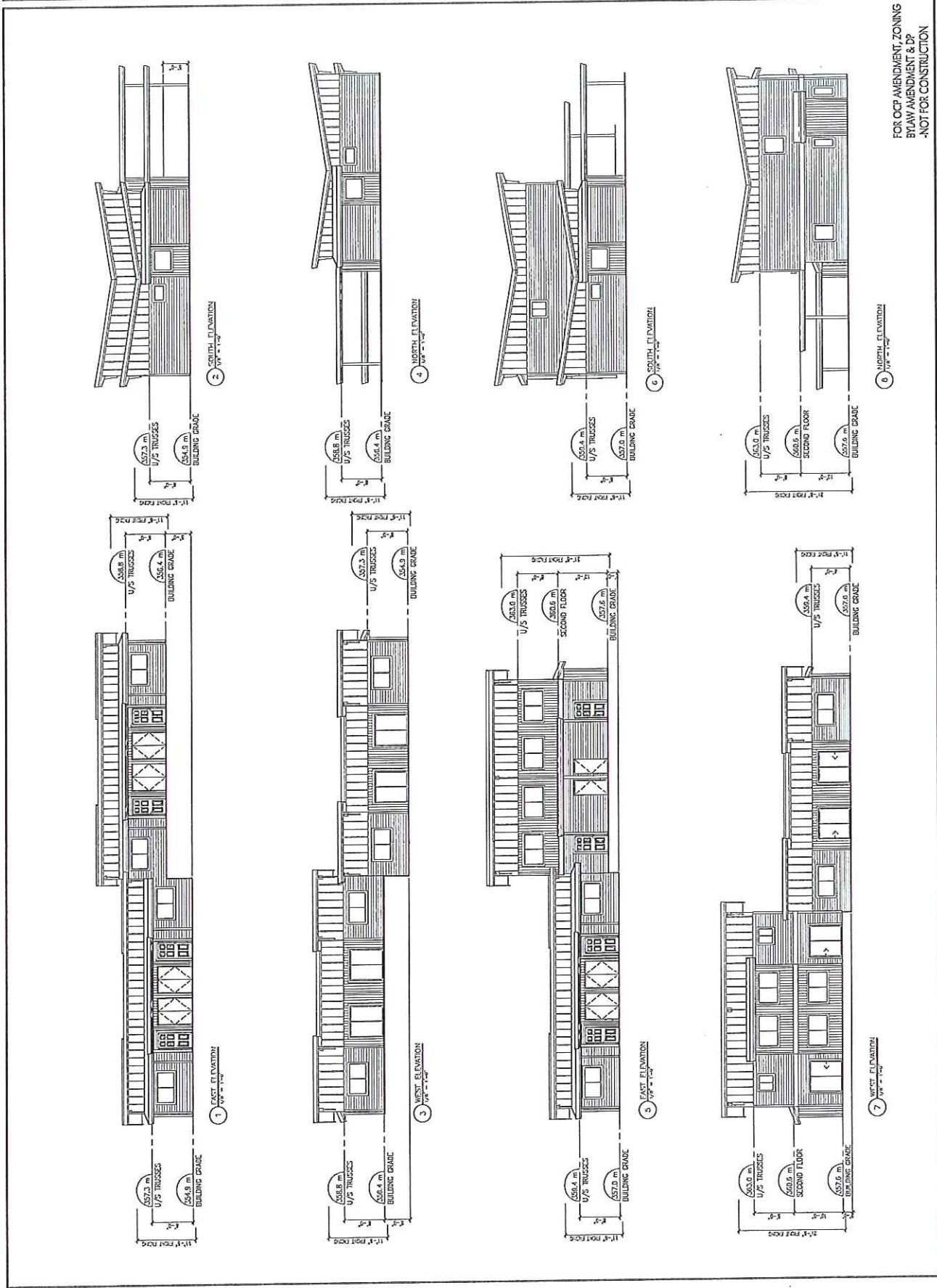

FOR OCP AMENDMENT, ZONING  
 BYLAW AMENDMENT & DP  
 -NOT FOR CONSTRUCTION

FOR OCT AMENDMENT, ZONING  
 BYLAW AMENDMENT & DP  
 -NOT FOR CONSTRUCTION

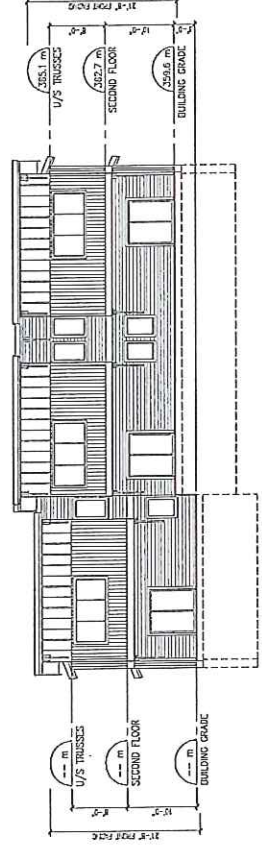
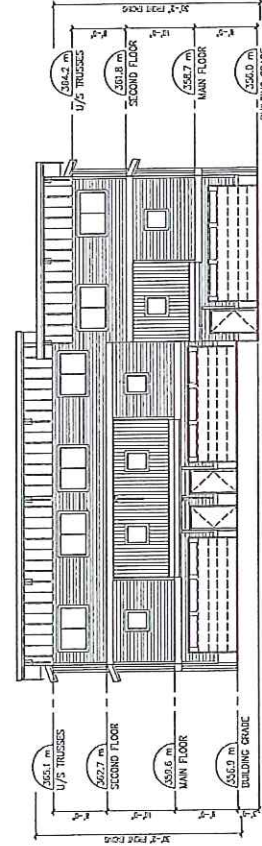
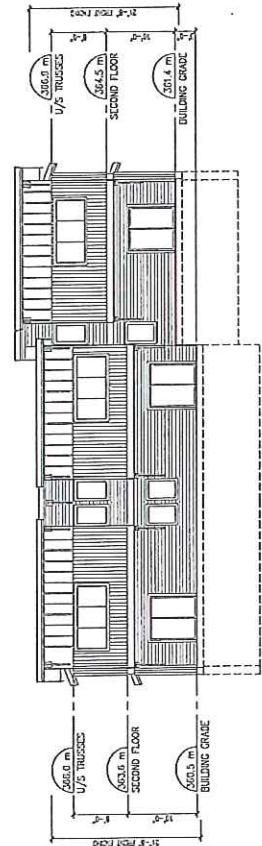
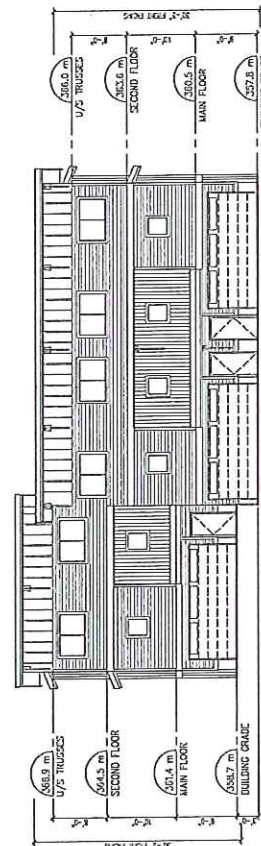
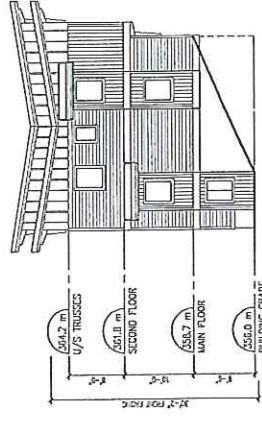
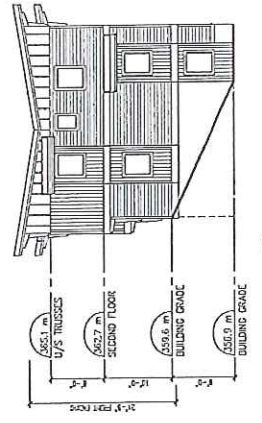
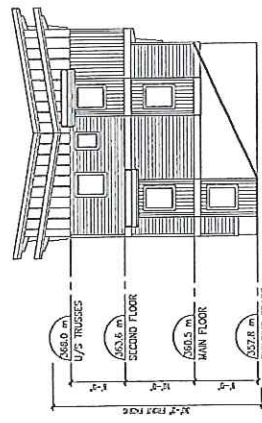
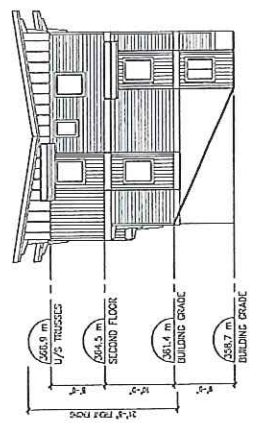



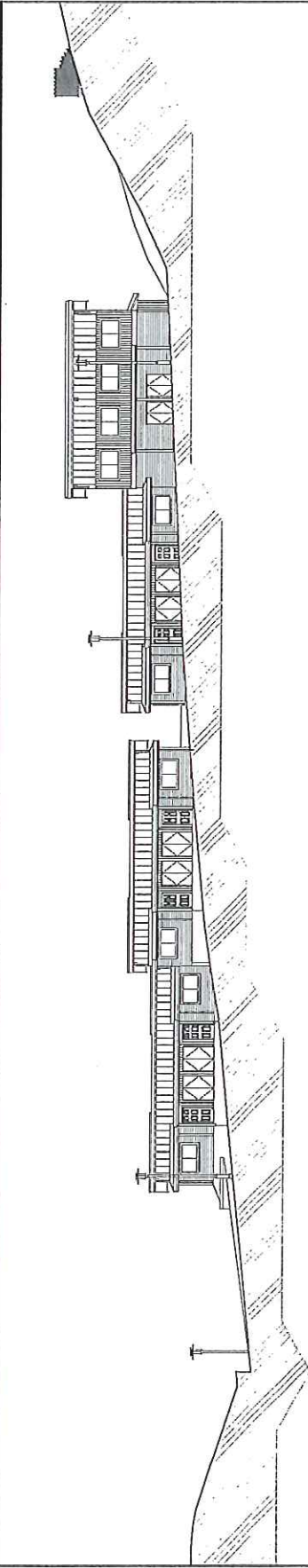

1 SITE SECTION  
1/8" = 1'-0"

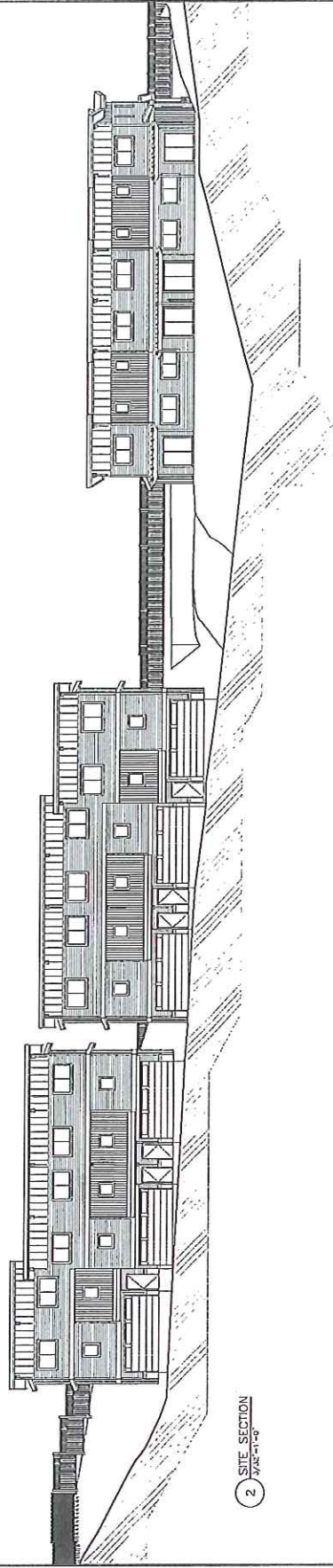

2 SITE SECTION  
1/8" = 1'-0"

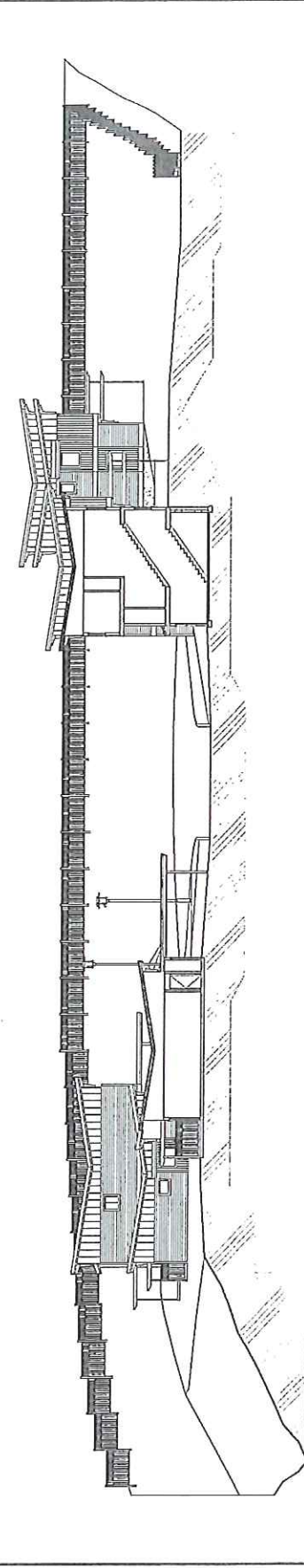

3 SITE SECTION  
1/8" = 1'-0"

FOR OCCUPANCY, ZONING  
 BYLAW AMENDMENT & DP  
 -NOT FOR CONSTRUCTION



THIS DOCUMENT IS THE PROPERTY OF DISTRICT 11. IT IS TO BE USED ONLY FOR THE PROJECT AND SITE SPECIFICALLY IDENTIFIED HEREIN. ANY REUSE OR MODIFICATION OF THIS DOCUMENT WITHOUT THE WRITTEN PERMISSION OF DISTRICT 11 IS STRICTLY PROHIBITED. DISTRICT 11 ASSUMES NO LIABILITY FOR ANY ERRORS OR OMISSIONS IN THIS DOCUMENT. THE USER OF THIS DOCUMENT SHALL BE RESPONSIBLE FOR OBTAINING ALL NECESSARY PERMITS AND APPROVALS FROM THE APPROPRIATE AGENCIES. DISTRICT 11 DOES NOT WARRANT THE ACCURACY OR COMPLETENESS OF THE INFORMATION CONTAINED HEREIN. THE USER OF THIS DOCUMENT SHALL BE RESPONSIBLE FOR OBTAINING ALL NECESSARY PERMITS AND APPROVALS FROM THE APPROPRIATE AGENCIES. DISTRICT 11 DOES NOT WARRANT THE ACCURACY OR COMPLETENESS OF THE INFORMATION CONTAINED HEREIN.

---

CITY OF KELOWNA  
MEMORANDUM

---

**Date:** August 19, 2011  
**File No.:** Z11-0047  
**To:** Lan Use Management (JM)  
**From:** Development Engineering Manager (SM)  
**Subject:** Rezoning Application – Requirements

<b>LOCATION:</b> 1170 Brant Ave Lot 3 Plan 10537
<b>ZONE:</b> Existing RU1
<b>APPLICANT:</b> Architecturally Distinct Solutions
<b>LEGAL:</b> Lot 3 Plan 10537

The Development Engineering comments and requirements regarding this application to rezone the subject property from RU1 to RM3 are as follows:

**.1) General**

- a) The postal authorities must be contacted to determine whether or not a "community mailbox" will be utilized, and if so, its location should be determined and the proposed location shown on the construction plans. Please contact the Canadian Post Corporation, Delivery Services, P.O. Box 2110, Vancouver, B.C. V6B 4Z3 (604) 662-1381 in this regard.

**.2 Geotechnical Report**

- a) Provide a comprehensive geotechnical report (3 copies), prepared by a Professional Engineer competent in the field of hydro-geotechnical engineering to address the items below: **NOTE: The City is relying on the Geotechnical Engineer's report to prevent any damage to property and/or injury to persons from occurring as a result of problems with soil slippage or soil instability related to this proposed subdivision.**

The Geotechnical reports must be submitted to the Planning and Development Services Department (Planning & Development Officer) for distribution to the Works & Utilities Department and Inspection Services Division prior to submission of Engineering drawings or application for subdivision approval.

- (i) Area ground water characteristics, including any springs and overland surface drainage courses traversing the property. Identify any monitoring required.



- (ii) Site suitability for development.
- (iii) Site soil characteristics (i.e. fill areas, sulphate content, unsuitable soils such as organic material, etc.).
- (iv) Any special requirements for construction of roads, utilities and building structures.
- (v) Construction of building sites must adhere to the requirements outlined in the geotechnical and drainage reports, and all construction, placement of structural fill, etc., must be supervised by a geotechnical engineer including provision of compaction test records, etc.
- (vi) Suitability of on-site disposal of storm water, including effects upon adjoining lands.
- (vii) Identify slopes greater than 30%.
- viii) Recommendations for items that should be included in a Restrictive Covenant.
- ix) Any items required in other sections of this document.
- x) Recommendations for erosion and sedimentation controls for water and wind.
- xi) Recommendations for roof drains and perimeter drains.

### **.3 Water**

- a) The property is located within the City Water service area and has been serviced as part of the previous subdivision application.
- b) The water system must be capable of supplying domestic and fire flow demands of the project in accordance with the Subdivision, Development & Servicing Bylaw. Provide water calculations for this rezoning application to confirm this.
- c) Ensure every building site is located at an elevation that ensures water pressure is within the bylaw pressure limits. Note: Private pumps are not acceptable for addressing marginal pressure.

### **.4 Sanitary Sewer**

- a) This property is located within the City sanitary service area and has been serviced as part of the previous subdivision application. It is up to the applicant to confirm if the existing service is adequate.

### **.5 Drainage**

- a) Provide an adequately sized drainage system complete with individual lot connections. The Subdivision, Development and Servicing Bylaw requires that each lot be provided with an individual connection; however, the City Engineer may permit use of individual ground water disposal systems,

where soils are suitable. For on-site disposal of drainage water, a hydrogeotechnical report will be required complete with a design for the disposal method (i.e. trench drain / rock pit). The Lot Grading Plan must show the design and location of these systems for each lot.

- b) Provide the following drawings:
  - i) A detailed Lot Grading Plan (indicate on the Lot Grading Plan any slopes that are steeper than 30% and areas that have greater than 1.0 m of fill);
  - ii) A detailed Stormwater Management Plan for this subdivision; and,
  - iii) An Erosion and Sediment Control Plan.
- c) Show details of dedications, rights-of-way, setbacks and non-disturbance areas on the lot Grading Plan.
- d) Provide details of cuts and fills on the Lot Grading Plan.

**.6) Roads**

- a) The roads have been upgraded in association with the previous subdivision application. No further Road upgrades are required at this time.

**.7) Power and Telecommunication Services and Street Lights**

- a) All proposed distribution and service connections are to be installed underground.
- b) Street lights must be installed on all roads.
- c) Before making application for approval of your subdivision plan, please make arrangements with FortisBC for the pre-payment of applicable charges and tender a copy of their receipt with the subdivision application.
- d) Make servicing applications to the respective Power and Telecommunication utility companies. The utility companies are required to obtain the City's approval before commencing construction.

**.8) Design and Construction**

- a) Design, construction, supervision and inspection of all **off-site civil works** and site servicing must be performed by a Consulting Civil Engineer and all such work is subject to the approval of the City Engineer. Drawings must conform to City standards and requirements. See Council Policy Number 91 for Bareland Strata subdivisions
- b) Engineering drawing submissions are to be in accordance with the City's "Engineering Drawing Submission Requirements" Policy. Please note the number of sets and drawings required for submissions.

- c) Quality Control and Assurance Plans must be provided in accordance with the Subdivision, Development & Servicing Bylaw No. 7900 (refer to Part 5 and Schedule 3)
- d) A "Consulting Engineering Confirmation Letter" (City document 'C') must be completed prior to submission of any designs).
- e) Before any construction related to the requirements of this subdivision application commences, design drawings prepared by a professional engineer must be submitted to the City's Works & Utilities Department. The design drawings must first be "Issued for Construction" by the City Engineer. On examination of design drawings, it may be determined that rights-of-way are required for current or future needs.

**.9) Servicing Agreements for Works and Services**

- a) A Servicing Agreement is required for all works and services on City lands in accordance with the Subdivision, Development & Servicing Bylaw No. 7900. The applicant's Engineer, prior to preparation of Servicing Agreements, must provide adequate drawings and estimates for the required works. The Servicing Agreement must be in the form as described in Schedule 2 of the bylaw.
- b) Part 3, "Security for Works and Services", of the Bylaw, describes the Bonding and Insurance requirements of the Owner. The liability limit is not to be less than \$5,000,000 and the City is to be named on the insurance policy as an additional insured.

**.10) Other Engineering Comments**

- a) Provide all necessary Statutory Rights-of-Way for any utility corridors required, including those on proposed or existing City Lands.

**.11) Charges and Fees**

- a) Fees per the "Development Application Fees Bylaw" include:
  - i) Street/Traffic Sign Fees: at cost if required (to be determined after design).
  - ii) Survey Monument Fee: \$50.00 per newly created lot (GST exempt).
  - iii) Survey Monument, Replacement Fee: \$1,200.00 (GST exempt) – only if disturbed.
  - iv) Engineering and Inspection Fee: 3% of off-site construction value (plus GST).

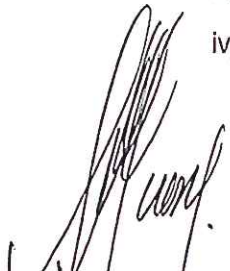

---

Steve Muehze, P.Eng.  
Development Manager  
DC

## Design Rationale

1170 Brant Avenue, Kelowna, BC



September 13, 2011

**Re: 1170 Brant Avenue, Kelowna, BC**  
**OCP Amendment/Zoning Bylaw Amendment/DP/DVP Application**  
**Design Rationale**

Dear Mayor Sharon Shepherd and Council Members,

**Introduction**

In keeping with the City of Kelowna's strategic approach to urban growth including the vision for more sustainable development, we would like to present to you the design rationale for the residential development of 1170 Brant Avenue (The Site). This design rationale is for the benefit of the Planning Department during its consideration of the OCP Amendment/Zoning Bylaw Amendment/DP and DVP application submissions associated with The Site.

The new owners of this property have assembled a multi-disciplinary development team. Our team has been working to ensure that we will be bringing Kelowna a unique, affordable sustainable neighbourhood that we believe the market truly desires.

Our proposal for The Site is to rezone from the current OCP designation to a Multiple Unit Residential – Low Density (RM3) designation.

The subject property has received PLR approval for 9 single-family residential strata lots. All the infrastructure, (roads, water, stormwater, sanitary sewer, natural gas, and electrical service), has already been put in place. It is our understanding that the present OCP designation for single/two-family dwellings on the nine lots could accommodate 18 residential units.

Our proposal is to rezone the property to Multiple Unit Residential – Low Density (RM3) designation to accommodate the construction of 18 residential units. While the proposed density is allowed under the present OCP designation, the form and character of the development is different. Through this proposal, we intend to provide to 18 townhome style residences on the site, four of which will be offered for sale at prices based on the city's affordable housing policy. These four units will be self-contained homes, complete with covered parking and large yards. Our experience with this type of housing leads us to believe there will be fewer families and children and more young working couples living in the development.

The proposed residential development for The Site is as follows:

- 14 townhome-style residential units.
- 4 townhome-style affordable residential units (22% of total number of units).
- Geothermal heating and cooling systems in all residential units including the affordable homes.
- Covered parking for all residences.
- Large private yards for all residences.

The affordable housing model for this project means that we are able to introduce more than 22% of the overall proposed residential units as affordable homes. The affordable homes proposed consist of four, 2-bedroom, 1-den homes offered for sale as Affordable Housing under the City's Affordable Housing Policy and guidelines. Specifically, these housing units will be sold below market pricing under the homeowner's legal commitment to live in the unit for ten years. These homes will be available to buyers whose total household income qualifies under the City of Kelowna's guidelines. The units may be resold, but a legal covenant will be registered against the property that restricts the resale price of any affordable home to be no greater than the original purchase

price plus the cost of living index established by the City, thereby ensuring that purchasers of affordable housing are long-term, committed owners who take pride and care in their investment and are more likely to stay in the community. The remaining 14 homes will be sized between 1240 and 1650 square feet and will consist of 3 bedroom homes with covered or enclosed parking for 2 vehicles.

Each home will have the luxury of its own large, fully landscaped back yard and the property has been carefully fenced to provide privacy and separation for the new home owners and their existing neighbours. We anticipate all the homes provided on this site will be heated and cooled with geothermal systems, a model our team has developed with Fortis on another neighbourhood we are currently building. (Please refer to the attached letter of support from Fortis BC) This geothermal model gives ownership and the responsibility for maintenance of the geothermal field to Fortis and allows the owners of the Strata units to pay one simple, affordable monthly fee for a large portion of the heating and cooling expense.

### The Property

Situated between the industrialized area at the north end of Gordon Drive and the adjacent residential neighbourhood to the north and east, The Site is ideally located to allow for the successful integration of a truly transitional RM3 density development (see 'Plan Location' below). The transitional location between industrial properties and existing neighbourhood is complimented by its physical transition between the two land uses. Located several meters below the single family homes to the north and several meters above the light industrial area to the west, this property seamlessly integrates into its location without imposing visual obstructions to the homes above and maintaining physical separation from the light industrial area below (see 'Contour Plan' and 'Existing View'(s) below). Further to the notion of integration, we have ensured that colour and material selections compliment the existing natural setting (see 'Proposed View' below).



Plan Location



Contour Plan



Proposed View of the Development from above (looking north east from entry off of Brant Avenue)

The new ownership group has listened very carefully to all of the concerns of neighbours, City staff, and Council from previous applications and has brought back a plan with a much lower density, of only 18 units, which represents the same number of units that would be currently allowed under the properties current OCP designation, 4 of which, as mentioned previously, will be priced according to the City's affordable housing.

This proposed neighbourhood is the ideal solution for this unique piece of property. The previous ownership group was attempting to sell the 9 RU1 lots separately as a family residential neighbourhood. This did not prove effective due to the necessary pricing of the homes and lots to be offered for sale.

Through experience gained with the very successful sales of townhomes in the Glenmore area, the development team has designed this property to give young urban home buyers an affordably priced, high quality product that is close to many of the city's main business areas and attractions. We have found that location, size, price, interior and exterior finishing levels and the energy efficiency of a development are key features that many of today's young first and second time home buyers are actively looking for but are struggling to find. This property and the proposed development of it, is the ideal solution for this market. With the property bordered by light industrial, residential, and Brant's Creek, the already completed civil works were constructed very carefully to insure seamless integration between these three unique qualities. The proposed development of this property will continue to handle all these factors with the utmost care to insure that there will be little or no effect to the bordering neighbours and the future home buyers have a property that will be a great place to call home.

This unique site offers the opportunity to place an affordable energy efficient home, at the necessary price point, near the heart of the city allowing first time home buyers and professionals the opportunity to have ownership of not only an affordably priced home, but one of the most cost effective energy efficient homes in the city, with geothermal fixed monthly heating and cooling and costs, tankless hot water systems to conserve electricity and water as well as being only one of two projects in the entire Okanagan that will be Energy Star rated.

Benefits of the proposed RM3 model:

- Opportunity to introduce much needed affordable housing.
- Introduce a mix of residential housing types to help integrate neighbourhood development.
- Provision of high energy efficiency integrated systems to all residence thereby contributing to a more sustainable heating and cooling approach for the homes.

To summarize this comprehensive development proposal, the ownership and the development team are bringing forward a new neighbourhood that will provide an excellent use of previously serviced land, with well valued and affordable homes, that will truly provide complimentary and sensitive integration into the existing multi-use neighbourhood.

We look forward to the City's consideration of our OCP Amendment/Zoning Bylaw Amendment/DP/DVP applications for this project.

Please do not hesitate to contact our office if you have any questions or require additional information.

Sincerely,  
Matt Johnston, MAIBC, MRAIC, LEED AP  
**Architecturally Distinct Solutions Inc.**



1975 Springfield Road  
Kelowna, BC V1Y 7V7  
Tel: 250-868-4554  
Cell: 250-215-4564  
[www.fortisbc.com](http://www.fortisbc.com)

June 20, 2011

City of Kelowna  
1435 Water Street  
Kelowna, BC  
V1Y 1J4

Attention: To Whom it May Concern:

**Letter of Support – Development Permit Application to the City of Kelowna for the Brant Avenue Townhouse Project**

Developer, Mr. Roland Nadon, has applied to construct an 18 unit townhouse development to be located on Brant Avenue in the City of Kelowna. It is contemplated that the proposed homes will utilize an alternative energy system to provide heating and cooling to the occupants of these buildings.

FortisBC and Mr. Nadon are working towards an agreement whereby FortisBC will provide the alternative energy systems, very similar to his GlenValley project on Boynton Place that we are currently involved in. FortisBC is actively investing in alternative energy systems that utilize sustainable energy sources such as geexchange and waste heat via district energy systems. Our involvement provides added benefit as we manage projects from the initial concept stage to ongoing system operation and maintenance to ensure long-term safety and reliability.

The utilization of an alternative energy system will dramatically reduce the total energy consumption as compared to a building utilizing conventional energy for heating and cooling. We strongly support Mr. Nadon's alternative energy approach. By reducing the carbon footprint of his multi-family project, we believe that he will provide environmental benefits to both local citizens and the broader community.

Please contact me at 250-868-4554 if you require further information.

Yours truly,

**FortisBC Energy Inc.**

Wade Benner, CTech  
Energy Solutions Manager